

Zontos-Z3

Hydrogen Water Generator

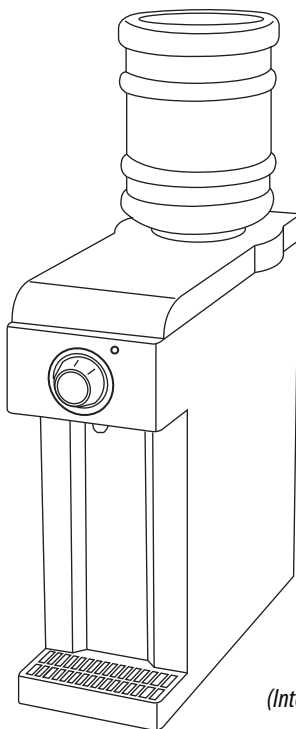

*"Awarded a Silver Medal at the 2015
Salon International
Des Inventions de Geneve
(International Exhibition of Inventions Geneva)
for selectively producing water with a high
concentration of hydrogen for domestic use"*

- Read this manual carefully before use.
- The design and specifications are subject to change for improvement of performance without prior notice.
- The appearance and colors may differ from the model shown on the cover.

Contents

1. Product Features	2
2. Parts, Indicators and Controls	3
3. Safety	4,5
4. Precautions	5
5. Operating Instructions	6
6. Cleaning Instructions	7
7. Warnings	8
8. Troubleshooting	9
9. Product Specifications	9
10. Warranty	10

1. Product Features

- This Zontos-Z3 is a Hydrogen Water Generator that produces drinking water with a high concentration of dissolved molecular hydrogen (2.0 to 3.0 ppm) continuously.
- The simple design allows anyone to easily install and operate the Zontos-Z3.
- Unlike water ionizers, the Zontos-Z3's unique process does not raise the water pH to dangerous levels.

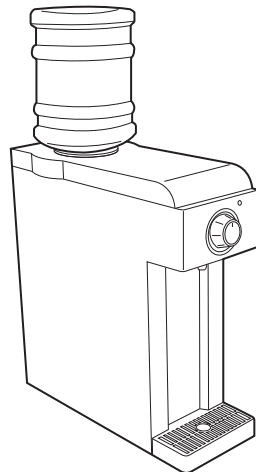

2. Parts, Indicators and Controls

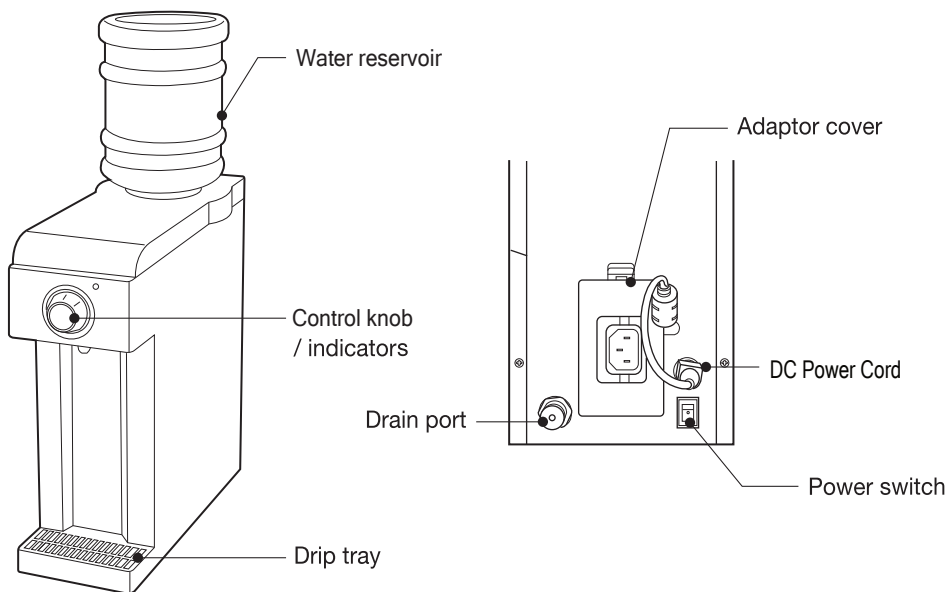

Status Indicator

In water-intake, lights turn on sequentially from the right to the left. When the unit is operating normally, the lights rotate. The lights flash when the unit requires repair.

Flow Indicator

The light turns on when Hydrogen Water is flowing to illuminate the water level in your container.

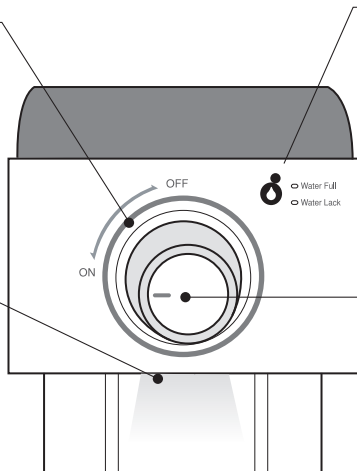

Water Level Indicator

Blue light on:
The water level is adequate.
Red light on:
The water level is too low.

Control Knob (on/off)

Turn counter-clockwise (to the left) to dispense Hydrogen Water. Turn clockwise (to the right) to turn off.

3. Safety

Warning

Violation of these rules can result in serious injury or death.

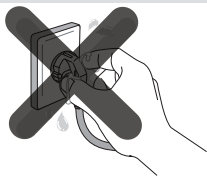

Make sure your hands are dry when plugging or unplugging the unit (electric shock hazard).

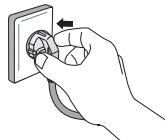

Fully insert the plug to avoid fire caused by a loose connection. This unit must only be plugged into a power outlet that is protected by a GFCI (ground-fault circuit interrupter).

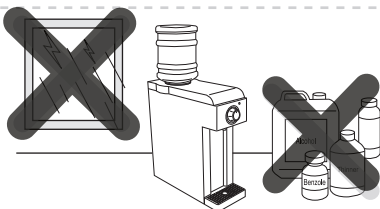

Do not install the unit in areas such as bathrooms, shower rooms or outdoors where there is high humidity or where the unit could get wet (electric shock hazard). Do not install the unit near inflammable substances (fire hazard).

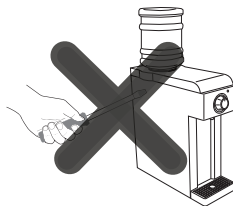

Do not attempt to disassemble or repair the unit.

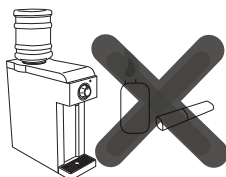

Keep the unit away from all sources of heat such as lighters, cigarettes, candles, space heaters, ect. (fire hazard).

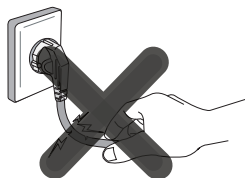

Disconnect (unplug) the unit from the power supply if the cord is damaged (electric shock and fire hazard).

Do not apply liquids, chemicals or cleaning products to the unit (health, electric shock and fire hazard). Do not place small metal objects on the unit (electric shock and fire hazard).

Disconnect (unplug) the unit from the power supply before cleaning.

Caution

Violation of these rules can result in serious injury or damage to the unit or other property.

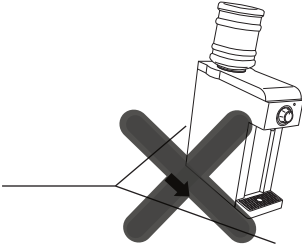

Do not operate the unit if it is not resting on a stable and level surface (risk of malfunction or damage).

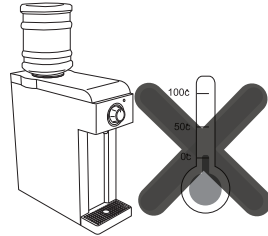

Do not install the unit in a place where there is direct sunlight or where the ambient temperature gets below freezing (32°F / 0°C) (risk of damage to the unit).

Do not operate the unit continuously for more than 15 minutes (risk of pump damage).

4. Precautions

1) When moving the unit a short distance (say between rooms):

- Dispense water into a container until the Level Indicator light glows red.
- Remove the Water Reservoir.
- Disconnect (unplug) the unit.
- Keep the unit upright while moving it to the new location.

2) When transporting the unit (say to a different building):

- Dispense water into a container until the Level Indicator light glows red.
- Remove the Water Reservoir.
- Disconnect (unplug) the unit.
- Drain all remaining water from the drain port (see page 8).
- Keep the unit upright while moving it to the new location.

3) When moving the unit, do not tip it by more than 45°. Note that excessive tipping may cause internal damage and malfunction of the unit.

5. Operating Instructions

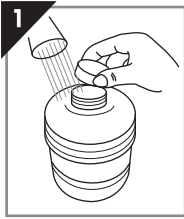

Before using the unit, remove the cap from the Water Reservoir, wash both in clean water and then rinse thoroughly .

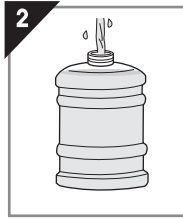

Fill the Water Reservoir with purified or mineral water.

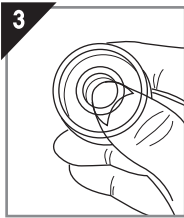

Push the rubber stopper into the plastic cap to close it. Screw the cap gently onto the top of the Water Reservoir.

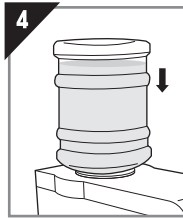

Invert the Water Reservoir and fit it into the opening on top of the unit. Push down gently to seat it. The prong inside the opening will pop the rubber stopper open.

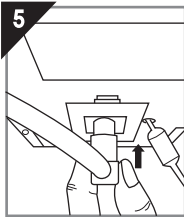

Plug the 3-pin power cord into the adapter at the back of the unit.

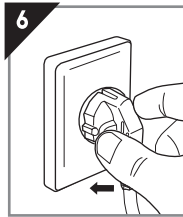

For initial use, wait 3 minutes (to allow the water to correctly fill the machine) and then plug the 3-pin power cord into a wall outlet.

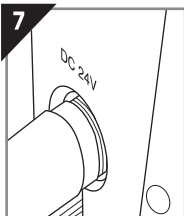

Plug the DC power cord into the back of the unit.

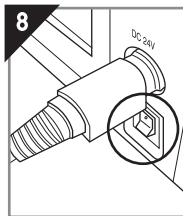

Turn the Power Switch on.

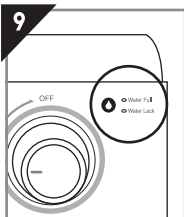

Check the Water Level Indicator light glows blue (sufficient water).

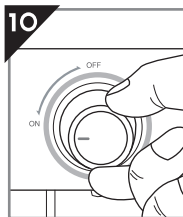

Place a glass/bottle under the nozzle or on the drip tray and start dispensing Hydrogen Water by turning the knob counter-clockwise. Stop dispensing by turning clockwise.

6. Cleaning Instructions

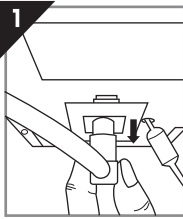

Dispense water until Water Reservoir is empty. Switch the unit off and remove the Water Reservoir. Unplug the 3-pin power cord from the wall and from the adapter

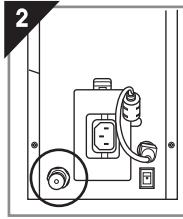

Drain any water remaining in the unit by removing the plug from the drain port in the back of the unit (see page 8 for details).

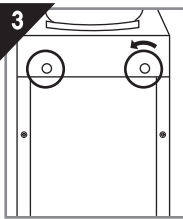

Loosen (but don't remove) the knurled bolts on the back of the unit at the top by turning them counter-clockwise.

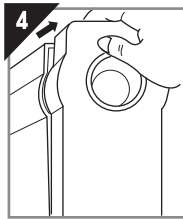

Remove the black lid from the unit by shifting it slightly forward and then lifting at the back.

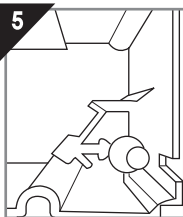

Clean the water receptacle chamber by wiping with a damp soft cloth or sponge (do not use detergent).

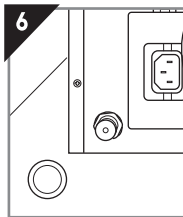

Place the back of the unit over a sink. Rinse the unit thoroughly by filling the water receptacle chamber with clean water and allowing it to run out of the drain port.

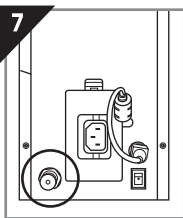

Repeat several times then replace the drain plug.



Replace the lid on the top of the unit and shift it slightly to the rear.

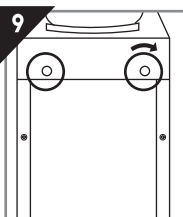

Gently tighten the knurled bolts on the back by turning them clockwise.

How to remove and replace the drain port plug

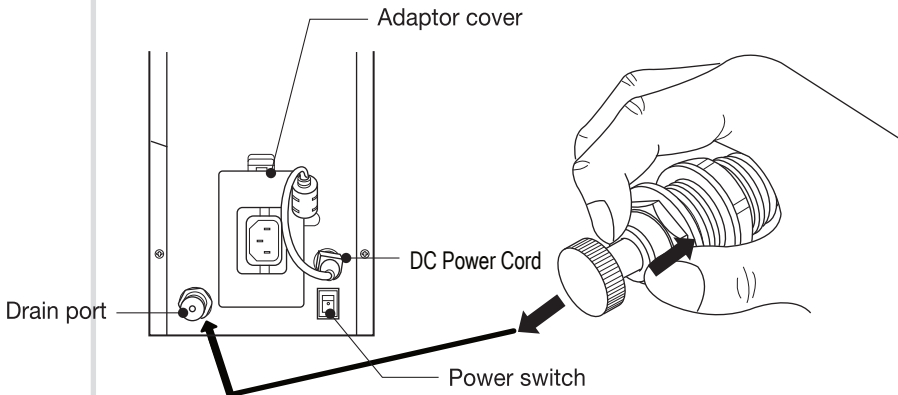

To remove, depress the collar on the fitting with one hand and pull the plug out with the other hand. To replace, simply push the plug gently back into the drain port.

7. Warnings

- 1) Only use clean and safe purified drinking water or mineral water. It is best to fill the reservoir from bulk bottled water or from a source of filtered drinking water (e.g. refrigerator water dispenser). Water that has been through reverse osmosis will not yield optimum performance.
- 2) Do not use well water, alkaline water, tea, coffee, milk, liquor, juice, etc. as these may damage the machine.
- 3) Make sure the rubber stopper in the plastic cap is closed before inverting the Water Reservoir and fitting it into the opening on top of the unit. This prevents water from spilling into the machine and damaging it.
- 4) Do not dispense water for longer than 15 minutes at a time. Doing so may damage the pump motor by overheating.
- 5) If the Water Level Indicator light is glowing red, you must refill the Water Reservoir.
- 6) If the Status Indicator lights are flashing (not rotating), the electrolytic cell must be replaced (see section 8 "Troubleshooting").
- 7) Keep the Hydrogen Water Generator in a temperature controlled environment.
- 8) Replace the post-filter in the Zontos Hydrogen Water Generator every 6-12 months dependent on source water.

8. Troubleshooting

Problem	Check	No	Yes
The Water Level Indicator light does not glow and the unit does not dispense water when turned on.	Is the 3-pin power cord connected into the adapter at the back of the unit and into a wall outlet, and is the DC power cord connected into the back of the unit? Is the Power Switch turned on?	Connect the 3-pin power cord and DC power cord correctly. Turn the switch on.	If the problem persists, contact the Authorized Service Center.
The unit does not dispense Hydrogen Water when the Control Knob is turned on.	Is the Water Level Indicator light glowing green?	If the Water Level Indicator light is not glowing, check the power supply as above. If the Water Level Indicator light is glowing red, refill the Water Reservoir.	Unplug the unit from the wall socket and contact the Authorized Service Center.
In operation, all of the process indicators flicker.	Switch off. Switch on again after one minute. Does the problem persist?	I can use the product normally.	Contact the Authorized Service Center.
The Water Level Indicator light is glowing red.	Is there any water in the Water Reservoir?	Refill the Water Reservoir.	Lift the Water Reservoir up slightly and then push it down firmly to make sure it is seated properly.
Your Hydrogen Water tastes abnormal.	Did you fill the Water Reservoir with clean and safe purified drinking water or mineral water?	Drain and clean the unit (see section 6), and then refill the Water Reservoir with clean and safe purified drinking water or mineral water.	If the problem persists, contact the Authorized Service Center.
There is a smell of burning when operating the unit.	Unplug the unit from the wall socket and contact the Authorized Service Center.		

9. Product Specifications

Product	• Zontos-Z3	Model	HHW-14
Size	5.2 x 14.2 x 14.2 (in)	Input Power	DC 24V/5A
Weight	9.9 lbs	Power consumption	about 110W
Water Reservoir Capacity	about 1 liter	Stand-by power	7W
Working Pressure	1~5 kgf/cm ²	Dissolved hydrogen density	2.0 ~ 3.0 ppm (Max 3.0ppm)
Working Temperature	39~95°F		

Warranty

1. This warranty covers manufacturing defects for the period stated below. Any faulty workmanship, parts, or materials will be repaired or replaced by the Authorized Service Center free of charge.
2. The following are not covered under this warranty:
 - i. Damage due to disregard for the warnings contained in this manual
 - ii. Abnormal use, or unauthorized repair or modification
 - iii. Consumable parts
 - iv. Damage caused by misuse, abuse, neglect, improper source water, alteration, repair, flooding, heat, accidents, etc.
3. To obtain service, the unit must be delivered to Authorized Service Center together with the original dated sales receipt.
4. Contact the Authorized Service Center before shipping to obtain a Return Merchandise Authorization (RMA).

Product	Electrolytic Hydrogen Water Generator	Warranty Period	
Model	Zontos-Z3	Two years from date of purchase	
SERIAL NO.			
Date of Purchase			
Address of Customer			
Name of Customer		TEL	

Authorized service center repair request, please review the installation and operation instructions provided in this manual carefully, and study the section on troubleshooting again.

If the problem is still not solved, stop operating the machine, unplug it from the wall outlet and contact the Authorized Service Center:

Zontos LLC Phone: (281)-825-5920

Email: info@zontoswater.com

